

Specification Sheet

Basin Pillar Taps

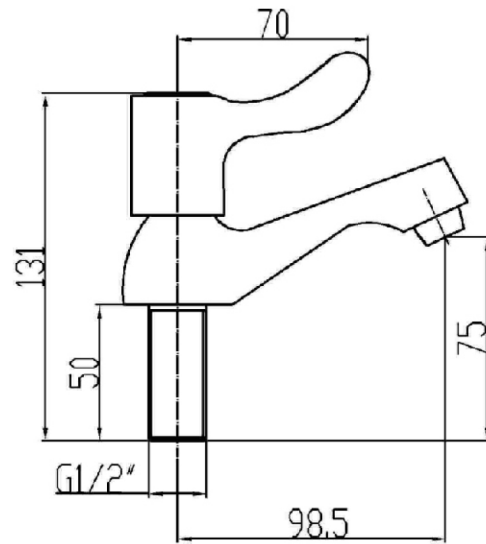

Product Specification

- Product Code:** 105-1
- Finish:** Chrome plated
- Construction:** Bodies of the tap are solid brass castings, and the handles are zinc cast; Solid brass casting produced from grade A brass
- Valve Type:** Quarter turn cartridge
- Supply:** Suitable for all plumbing systems
- Inlet Connections:** G1/2 female BSP loose nut
- Water Pressure:** Ranges from a minimum pressure of 0.2 to a maximum of 5.0 bar

Technical Advice: For further information please call 0208-3112329 or email sales@lavatataps.co.uk

Guarantee: The product carries a 5 year guarantee, excluding the ceramic (head/cartridge) which is covered by a 12 month guarantee

Flow Rates(litres per minute)

System Pressure	0.2 bar	0.3 bar	0.4 bar	0.5 bar	1 bar	2 bar	3 bar	4 bar	5 bar
105-1	5.20	6.90	7.80	9.50	14.30	20.20	25.10	27.60	30.10

For any information please email sales@lavatataps.co.uk

Or visit our web-site at www.lavatataps.co.uk
We reserve the right to make technical modifications without prior notice.