



RTE7RFD
RTE7RFB

INSTALLATION

INSTRUCTIONS

WIRELESS DIGITAL 7 DAY PROGRAMMABLE ROOM THERMOSTAT AND RECEIVER

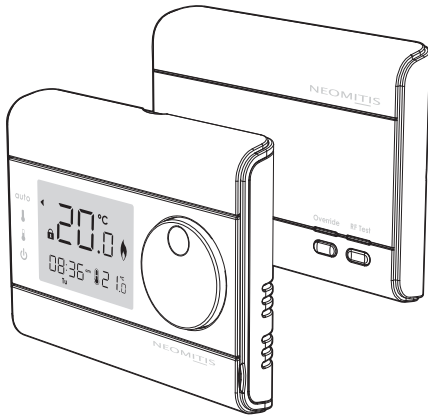
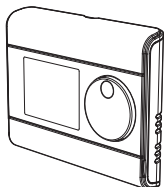

TABLE OF CONTENTS

Pack contains	1
Installation - Receiver	1
Mounting of wall mounting plate	1
Wiring	1
Mounting of the receiver	2
Installation - Thermostat	2
Installing batteries	2
Mounting of thermostat	2
Pairing procedure	3
Installer settings	4
Advanced installer setting	4
Operating states of the system	5
Troubleshooting	6
Technical specifications	6

PACK CONTAINS



x1
Thermostat

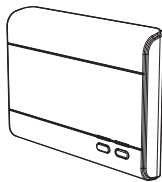

x1
Receiver

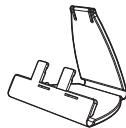

x1
Thermostat table stand



x2
AA Batteries (LR6)



x4
Screw Anchor



x4
Screws



INSTALLATION - RECEIVER

For best performance, do not mount the receiver on metal wall boxes and leave at least 30 cm distance from any metal objects including wall boxes and boiler housing.

MOUNTING OF WALL MOUNTING PLATE

The receiver is fixed on the wall with the standard wall plate which is supplied with the product.

1- Unscrew the 2 screws under the receiver.

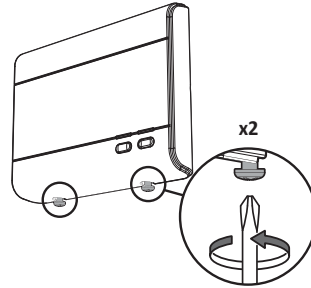

2- Remove the wall plate from the receiver.

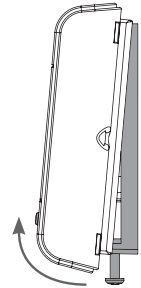

3- Secure the wall plate with the two screws provided using the horizontal and vertical holes.

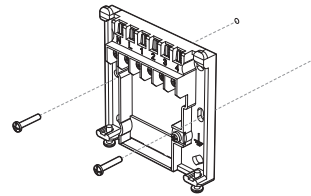

4- In case of surface mounting, a knock out area is provided on the wall plate and on the corresponding area of the receiver.

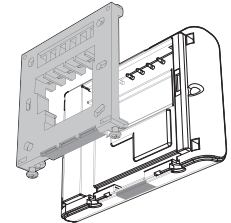

WIRING



All electrical installation work should be carried out by a suitably qualified Electrician or other competent person. If you are not sure how to install this thermostat consult either with a qualified electrician or heating Engineer. Do not remove or refit the receiver onto the backplate without the mains supply to the system being isolated.

All wiring must be in accordance with IEE regulations. This product is for fixed wiring only.

230V Connections

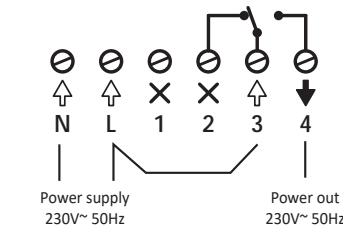
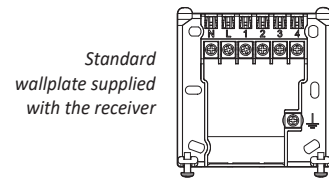

- N = Neutral
- L = Live
- 1 = Not used
- 2 = Not normally used
- 3 = Common - Power In 230V
- 4 = Call for heat - Power out 230V

Voltage Free Connections

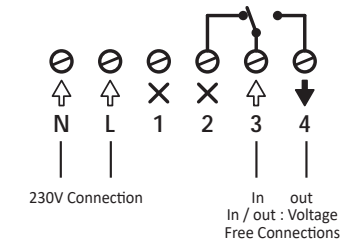
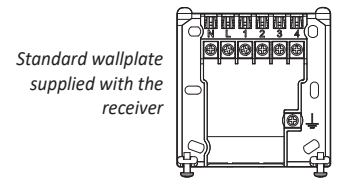

- N = Neutral
- L = Live
- 1 = Not used
- 2 = Not normally used
- 3 = Common - Power In: Voltage Free Connections
- 4 = Call for heat - Power Out: Voltage Free Connections

NOTE: The unit is double insulated so does not require an earth but a terminal is supplied for the spare wire.

MOUNTING OF THE RECEIVER

1- Replace the receiver on the wall mounting plate.

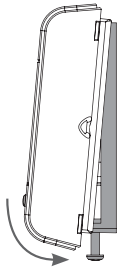

2- Secure the receiver by screwing the both locking screws under the receiver.

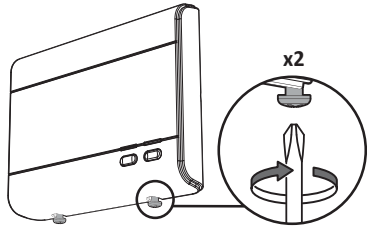

INSTALLATION - THERMOSTAT

Recommended locations for your thermostat.

To ensure that your thermostat provides accurate readings and controls effectively, it must be installed approximately 1.5 m above floor level on an inside wall, away from direct sunshine and any other sources of heat or cold such as radiators, cold draughts, etc.

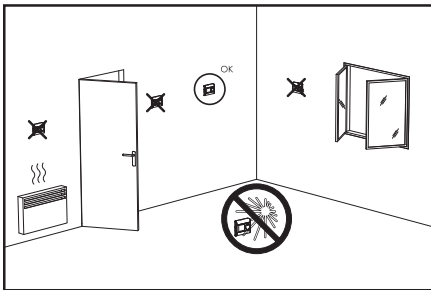

NB: In order to ensure proper operation of the product, ensure that the thermostat is not positioned near to an area which could be affected by interference from another source. E.g.: a wireless transmitter or receiver, TV, PC, etc.

Important: The thermostat measures the temperature of the place where it is installed. It does not take into account the temperature differences that may exist between different locations in the house if the temperature is not uniform.

INSTALLING BATTERIES

1- Remove the batteries cover which is placed on the front of thermostat.

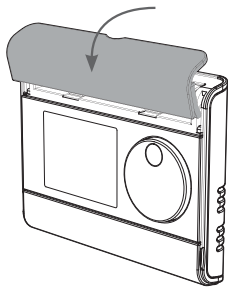

2- Insert the 2 batteries AA supplied. Note the correct polarity according to the engraving on the thermostat when inserting the batteries.

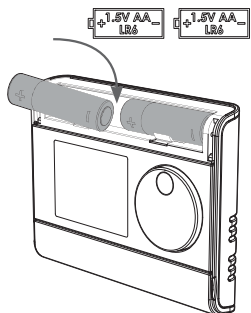

3- Replace the batteries cover.

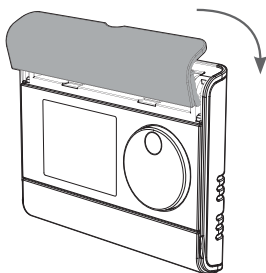

MOUNTING OF THERMOSTAT

On the wall

1- Unscrew the 2 screws under the thermostat.

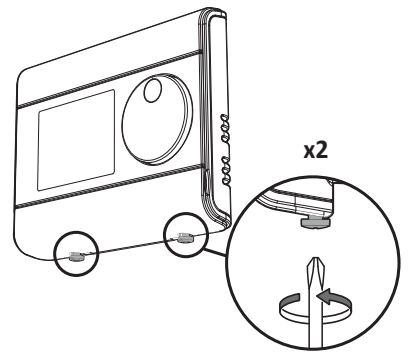

2- Remove the wall plate from the thermostat.

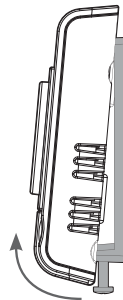

3- Secure the wall plate with the two screws provided using the horizontal and vertical holes.

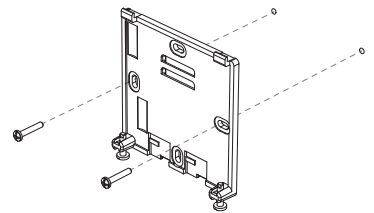

4- Replace the thermostat on the wall mounting plate.

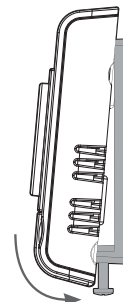

5- Secure the thermostat by screwing the locking screws under the thermostat.

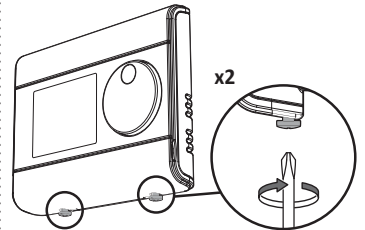

On the table stand

1- Insert the 2 pins inside the wallplate.

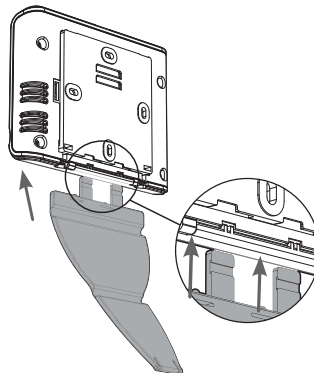

2- Slide the stand to the right.

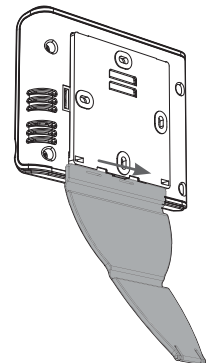

3- Fold the stand and lock it into the wallplate.

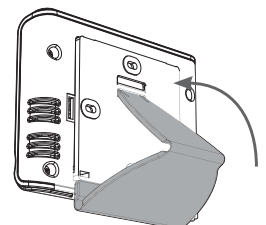

- 4- Tilt the thermostat according to its placement in the room. 2 tilts are available.

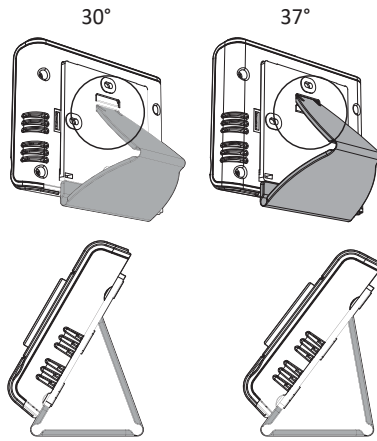

PAIRING PROCEDURE

The thermostat and the receiver are not bonded together at the factory. To bond the transmitter and the receiver together, proceed as below:

- 1- Press and hold for **5 seconds** the RF test button on the receiver. RF test green light is blinking.

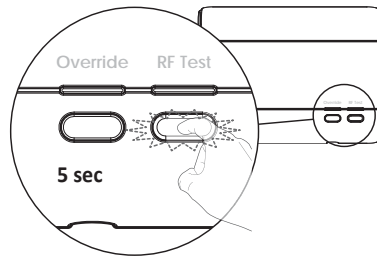

- 2- Within 1 minute, press and hold for **5 seconds** the RF test button on the thermostat. Pairing icon is flashing.

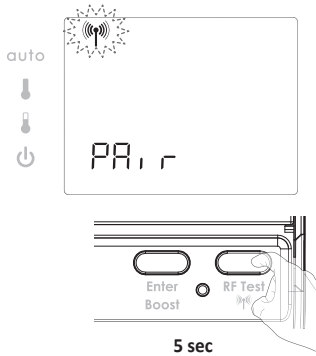

- 3- Thermostat RF icon and receiver green light are blinking.

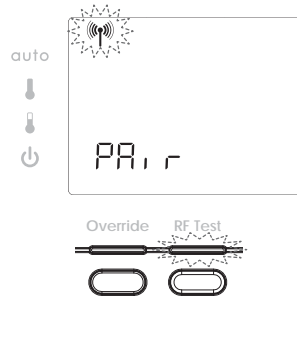

- 4- Thermostat RF icon and receiver green light will be solid when pairing is complete.



Note: the receiver is usually located near your boiler.

If you want to check the signal strength, move the mode slider to **U** position and then press and release the RF test button. RF icon blinks for 10 seconds then signal strength appears. 10 is the best signal strength.



PLEASE READ BEFORE PROGRAMMING THE THERMOSTAT

OPTIMISATION EXPLAINED

WHAT IS OPTIMISATION – OPTIMUM START?

Historically, most UK heating systems waste vast amounts of energy by firing unnecessarily early for most of the year. Homeowners tend to set their boiler on times based on when they wake up by guessing what time they feel that their boiler should fire in order to reach the requested target temperature; for example turning the boiler on at 6am in order to have a warm room/ home by their wake up time at 7am.

Dual function optimization, priority to comfort or energy savings, the choice is yours: Depending on various parameters: room inertia, ambient temperature, desired temperature, the thermostat calculates and optimizes the programming for each heating period whether set to Comfort or Savings (Eco):

In OPTI COMFORT mode, priority to comfort

In **OPTI COMFORT mode**, the thermostat's inbuilt algorithm optimises in order to guarantee maximum comfort during the COMFORT programme.

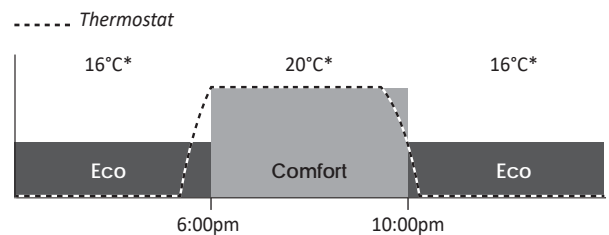

*Default temperature setting

The processor within the thermostat starts the boiler operation at the optimum time to achieve the setpoint temperature at the start of the occupancy period.

In this mode, the priority is given to anticipating and maintaining the comfort temperature during periods of occupancy.

In OPTI ECO mode, priority to energy savings

In **OPTI ECO mode**, the thermostat's inbuilt algorithm optimises in order to guarantee maximum energy savings throughout the ECO programme.

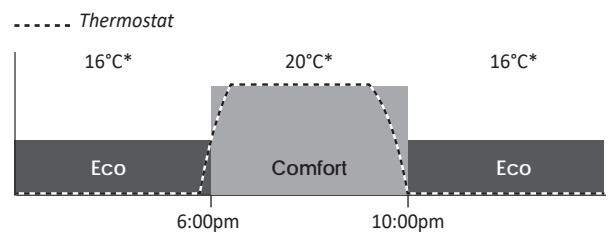

*Default temperature setting

In this mode, a slight drop in the temperature level at the beginning and end of the comfort period is allowed to maximize energy savings.

Instead of using a fixed start time, Optimum Start calculates how long the house will take to warm up depending on the temperature of the home, then fires the boiler automatically at the most efficient moment in order to reach your target temperature by your programmed time.

HOW DOES OPTIMUM START WORK?

Optimum Start works on a daily basis. You set the time that you want to be warm and Optimum Start will do the rest; for example - **if you wake up at 7:30AM, then set your thermostat's start time for 7:30AM**. Optimum Start ensures that you are warm when you want to be (and not before), reducing wasted energy and saving money (up to 10% of energy costs).

To change the optimization type, refer to the installation instructions/ advanced installer settings.



INSTALLER SETTINGS

ADVANCED INSTALLER SETTING

• Access

Move the mode slider to position.

Select the Programming slider position and press **Enter** for 5 seconds to go into the dedicated installer setting.

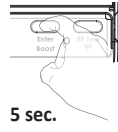
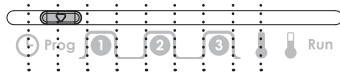

5 sec.

Slider position	Installer mode access
1	Set 12 or 24 hours clock
2	Enable/disable automatic summer/winter change
3	Set °C/°F temperature unit
4	Set calibration of the temperature displayed
5	Program lock
6	Select the type of control: 2 points or TPI
9	Optimization choice

• Set 12/24 hours clock



The pre-set value is 12 hours clock.

1- Rotate the dial to change to "24 hr".



2- Then save by pressing **Enter** or move the Programming slider.

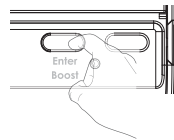

• Enable/disable automatic summer/winter change over



The summer/winter change will be performed automatically by the room thermostat.

1- Press and hold **Enter** for 5 seconds to access the setting mode.

ON appears on the display.



2- Rotate dial to the left to select "Off", to the right to select "On".



3- Then save by pressing **Enter** move the Programming mode.

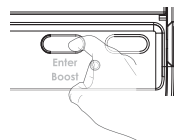

• Set °C/°F temperature



The pre-set temperature is Celsius (°C).

1- Rotate the dial to change to degree Fahrenheit.



2- Then save by pressing **Enter** or move the Programming slider.

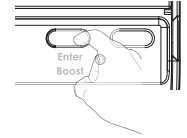

• Set calibration



Important: This operation is reserved for professional installers only; any wrong changes would result in control anomalies.

Change should only be made if the temperature measured (measured by a reliable thermometer) is different by at least 1°C compared to the setpoint temperature of the room thermostat.

The calibration adjusts the temperature measured by the ambient temperature sensor to compensate for a deviation from + 3°C to - 3°C in increments of 0.5°C.

IMPORTANT: Before carrying out the calibration it is recommended to wait for 4h after a setpoint temperature modification to insure that the ambient temperature is stabilized.

The pre-set calibration value is 0.

1- Rotate the dial to adjust the calibration to the desired value.



2- Then save by pressing **Enter** or move the Programming slider.

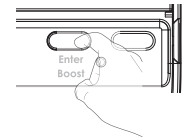

• Program lock

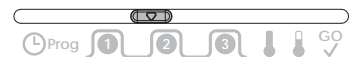

The product is unlocked by default, OFF is displayed.

When program lock function is turned on then following functions will be disabled:

- Regardless of physical location, Program Slider will always remain as per RUN mode (except to access Installer settings).
- In Mode Slider AUTO position: Manual override will not work.
- In Comfort Slider position: mode will remain as per AUTO mode.
- BOOST function is disabled.

1- Rotate the dial to ON and locked.



2- Then save by pressing **Enter** or move the Programming slider.

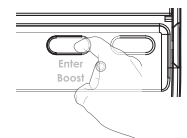

• Select 2 points/TPI



2 points = ON/OFF regulation.

TPI = Proportional control algorithm.

The pre-set control algorithm is TPI.

- 1- Rotate the dial to change to 2 points control algorithm.



- 2- Then save by pressing **Enter** or move the Programming slider.

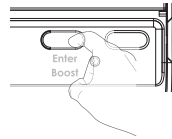

Note regarding the Advanced installer settings: If MODE slider is moved or no press/rotation for 15 seconds, it will discard changes and exit installer mode.

• Optimization feature



- Overview

Dual function optimization, priority to comfort or energy savings, the choice is yours: Depending on various parameters: room inertia, ambient temperature, desired temperature, the thermostat calculates and optimizes the programming for each heating period whether set to Comfort or Savings (Eco):

- In **OPTI ECO mode**, the thermostat's inbuilt algorithm optimises in order to guarantee maximum energy savings throughout the ECO programme. In this mode, a slight drop in the temperature level at the beginning and end of the ECO period is allowed to maximize energy savings. The processor within the thermostat stops the boiler operation at the optimum time to slightly reduce the setpoint temperature before the end of the occupancy period. In this mode, a slight drop in the temperature level at the beginning and end of the comfort period is allowed to maximize energy savings.
- In **OPTI COMFORT mode**, the thermostat's inbuilt algorithm optimises in order to guarantee maximum comfort during the COMFORT programme. The processor within the thermostat starts the boiler operation at the optimum time to achieve the setpoint temperature at the start of the occupancy period. In this mode, the priority is given to anticipating and maintaining the comfort temperature during periods of occupancy.

- Optimization choice

The OPTI COMFORT mode is activated by default.

- 1- Move the programming slider to position **1**.

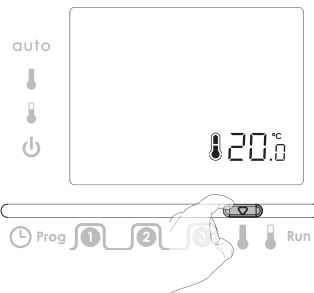

- 2- Press and hold **Enter** for 5 seconds to access the setting mode.

OP appears on the display, the set mode "CONF" and its corresponding icon flash. OP appears on the display, the set mode "CONF" and its corresponding icon flash.

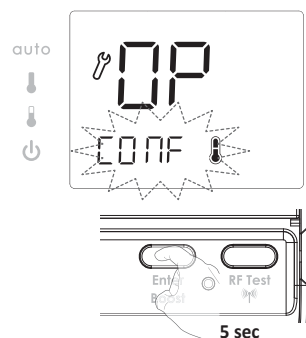

- 3- Turn the dial to select the desired mode:

OP CONF = Optimization feature activated for OPTI COMFORT mode, priority to comfort
OP ECO = Optimization feature activated for OPTI ECO mode, priority to energy efficiency
OP OFF = Optimization feature deactivated

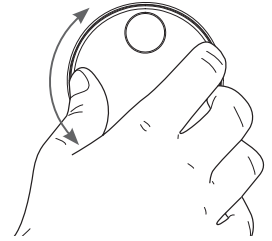

- 4- Press **Enter** to save, exit setting optimization feature and go back to the current mode.

OPERATING STATES OF THE SYSTEM

States of the indicator light	Operating states of the thermostat
Green	Receiver is connected to the thermostat
Orange	System is calling for heat
Red	RF Signal has been lost, no connection between thermostat and receiver. In order to re-bond the thermostat and receiver refer to page 3.

? TROUBLESHOOTING

Display disappears on thermostat.

- Check batteries.
- Replace the 2 batteries. Only use alkaline 1.5V AA (LR6) batteries.
Do not use rechargeable batteries.

The heating does not come on or does not go off.

- Your room thermostat may have been set up close to a source of heat or on a cold wall – put it in a recommended location (see the “Installing” section on page 2 for these locations).
- Check that the radio communication works between the thermostat and the receiver.
- Check if the boiler controlled by the programmable room thermostat is properly connected to the receiver.

Radio transmission is not working properly:

- 1- The receiver is not picking up the code sent by the thermostat.**
 - Check and replace thermostat batteries .
- 2- The receiver does not recognize transmitter’s code.**
 - Pair the room thermostat transmitter with the receiver again See Pairing section.
- 3- The receiver or the transmitter is affected by interference:**
 - Re site the transmitter.
 - If possible, re site the receiver away from the source of the interference.

You want to change the operating mode but when you move the mode slider nothing happens.

- If the lock symbol is being displayed, then the thermostat is locked.
- Unlock the thermostat by following the instructions for doing so in the "program lock" section (see page 4).

The thermostat is in Auto Mode but programs are not being executed by the boiler:

- Ensure that the thermostat is in good working condition.
- Change the batteries.

The radio link between the thermostat and the receiver is lost.

- Check the battery level status.
- Check that the radio communication works between the thermostat and the receiver. If the radio communication does not work between the receiver and the thermostat Conduct RF Test (see page 3).
- Repeat the pairing between the thermostat and receiver (refer to the pairing procedure on page 3).

The thermostat does not control properly.

- Thermostat sensor may be influenced by a source of heat or cold.
- Check that the radio communication works between the thermostat and receiver.

If the problem persists, contact your installer.

🔧 TECHNICAL SPECIFICATIONS

Power supply: 2 alkaline 1.5 V AA (LR6) batteries.
Manual temperature setting range: from +5°C to +30°C.
Battery life: approx. 2 years.
Radio frequency: 2,4035 Ghz / 2,4055 Ghz / 2,4075 Ghz
Maximum RF power transmitted: <1mW

Receiver:

- Power supply: 230V~50/60Hz.
- Relay outputs: 5(2)A.
- Rated impulse voltage: 4000V.
- Micro-disconnection: Type 1B.
- Pollution degree: 2.
- Automatic action: 100,000 cycles.
- Class II.

Maximum range in the home: 15m is typical but this varies depending on the building construction eg plasterboard lined with metal foil the number of walls and ceilings that the signal has to pass through and by the surrounding electromagnetic environment.

Signal sending: every 10 minutes, maximum time-lag 1 minute after set-point temperature has been changed.

Environment :

- Operation temperature: 0°C to +40°C.
- Storage temperature: from -10°C to +60°C.
- Humidity: 80% at +25°C (without condensation)
- Protection rating: IP30.

N.B.: this room thermostat is one part of a complete radio system and will only work with the 230V AC receiver.

Manufactured by: Neomitis Ltd (contactuk@neomitis.com)

EU declaration of conformity: We hereby declare under our sole responsibility that the products described in these instructions comply with the provisions of Directives and harmonized standards listed below :

Thermostat

- RED 2014/53/EU:
 - Article 3.1a (Safety): EN60730-1/ EN60730-2-7/EN60730-2-9 / EN62311
 - Article 3.1b (EMC): ETSI EN301489-1 / ETSI EN301489-3
 - Article 3.2 (RF): ETSI EN 300440
- Directive RoHS 2011/65/EU, amended by Directives 2015/863/EU and 2017/2102/EU : ROHS: EN50581:2012

Receiver

- RED 2014/53/EU:
 - Article 3.1a (Safety): EN60730-1/EN60730-2-9 / EN62311
 - Article 3.1b (EMC): ETSI EN301489-1/ ETSI EN301489-3
 - Article 3.2 (RF): ETSI EN 300440
- Directive RoHS 2011/65/EU, amended by Directives 2015/863/EU and 2017/2102/EU : ROHS: EN50581:2012

Products are manufactured using processes that are certified ISO 9001: 2015

The  on the product indicates that you must dispose of it at the end of its useful life at a special recycling point, in accordance with European Directive WEEE 2012/19/EU. If you are replacing it, you can also return it to the retailer from which you buy the replacement equipment. Thus, it is not ordinary household waste. Recycling products enables us to protect the environment and to use less natural resources.





RTE7RFD
RTE7RFB

OPERATING

INSTRUCTIONS

WIRELESS DIGITAL 7 DAY PROGRAMMABLE ROOM THERMOSTAT AND RECEIVER

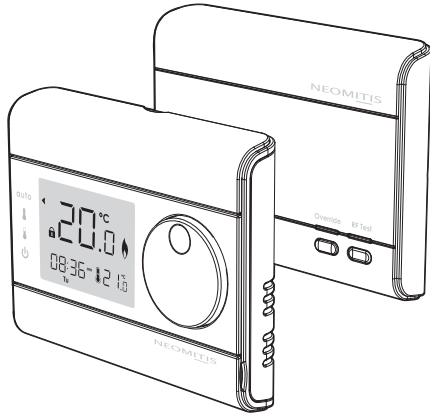
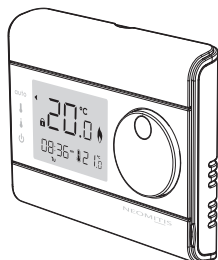

TABLE OF CONTENTS

- Overview 1
- Controls and display 1
- Settings 1
 - Initial power up 1
 - Pairing procedure 1
- Programming 3
 - Set date and clock 3
 - Set the program day 3
 - Set the program Comfort period 3
 - Temperatures setting 4
- Operating 4
 - Mode selection and description 4
 - Manual: a temporary change 4
 - Boost 4
 - Operating states of the system 5
 - Override 5
 - Factory settings 5
- Troubleshooting 5
- Technical specifications 6
- Note 6
- What is a room thermostat 6

OVERVIEW

Thank you for purchasing our RT7RFPLUS, wireless 7 day programmable digital room thermostat. It is by listening to your requirements we have created and designed our products to be easy to operate and install. It is this ease of operation that is intended to make your life easier and help you save energy and money.



CONTROLS AND DISPLAY

Thermostat

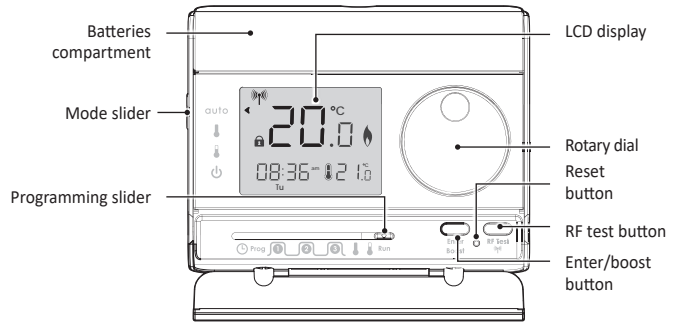

Programming sliders sequences:

Time/date → Day to be programmed → Comfort period setting → Comfort temperature → Eco temperature → Run



LCD Display

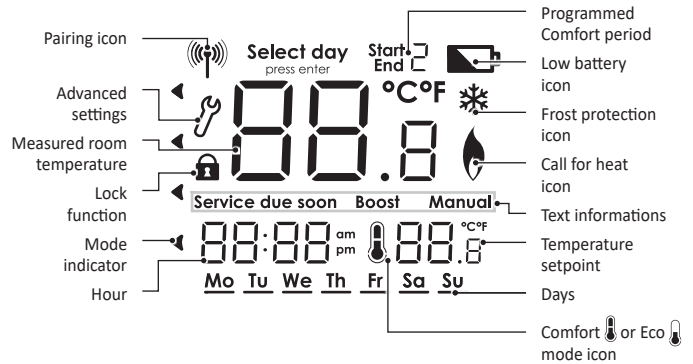

SETTINGS

INITIAL POWER UP

- 1- To start: insert the two AA batteries provided into the battery compartment. Once batteries are fitted all symbols will be displayed on the LCD screen as shown for two seconds.
- 2- After 2 seconds, the LCD will show:
 - The ambient temperature (°C) solid.
 - RF icon flashes.

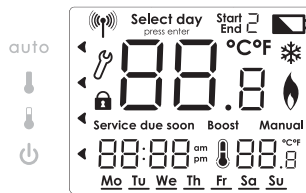

Note: When the batteries must be changed, a low battery level indicator appears on the device. Remember to take used batteries to battery collection points so they can be recycled.

PAIRING PROCEDURE

The thermostat and the receiver are not bonded together at the factory. To bond the transmitter and the receiver together, proceed as below:

- 1- Press and hold for 5 seconds the RF test button on the receiver. RF test green light is blinking.

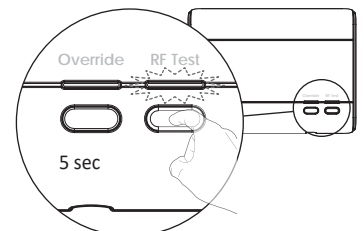

- 2- Within 1 minute, press and hold for 5 seconds the RF test button on the thermostat. Pairing icon is flashing.

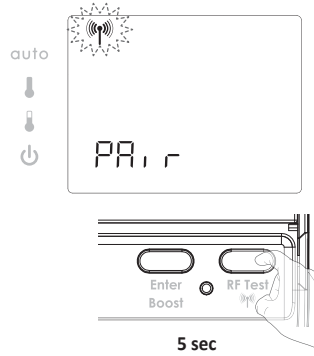

- 3- Thermostat RF icon and receiver green light are blinking.

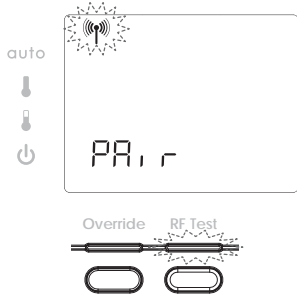

Note: the receiver is usually located near your boiler.

If you want to check the signal strength, move the mode slider to position and then press and release the RF test button. RF icon blinks for 10 seconds then signal strength appears. 10 is the best signal strength.

- 4- Thermostat RF icon and receiver green light will be solid when pairing is complete.

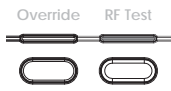

PLEASE READ BEFORE PROGRAMMING YOUR THERMOSTAT

In OPTI ECO mode, priority to energy savings

In OPTI ECO mode, the thermostat's inbuilt algorithm optimises in order to guarantee maximum energy savings throughout the ECO programme.

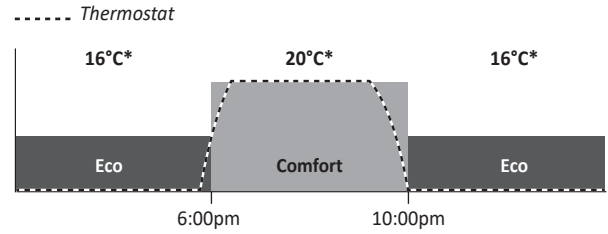

*Default temperature setting

In this mode, a slight drop in the temperature level at the beginning and end of the comfort period is allowed to maximize energy savings.

Instead of using a fixed start time, Optimum Start calculates how long the house will take to warm up depending on the temperature of the home, then fires the boiler automatically at the most efficient moment in order to reach your target temperature by your programmed time.

HOW DOES OPTIMUM START WORK?

Optimum Start works on a daily basis. You set the time that you want to be warm and Optimum Start will do the rest; for example - **if you wake up at 7:30AM, then set your thermostat's start time for 7:30AM.** Optimum Start ensures that you are warm when you want to be (and not before), reducing wasted energy and saving money (up to 10% of energy costs).

To change the optimization type, refer to the installation instructions/ advanced installer settings.

PLEASE READ BEFORE PROGRAMMING YOUR THERMOSTAT

OPTIMISATION EXPLAINED

WHAT IS OPTIMISATION – OPTIMUM START?

Historically, most UK heating systems waste vast amounts of energy by firing unnecessarily early for most of the year. Homeowners tend to set their boiler on times based on when they wake up by guessing what time they feel that their boiler should fire in order to reach the requested target temperature; for example turning the boiler on at 6am in order to have a warm room/ home by their wake up time at 7am.

Dual function optimization, priority to comfort or energy savings, the choice is yours: Depending on various parameters: room inertia, ambient temperature, desired temperature, the thermostat calculates and optimizes the programming for each heating period whether set to Comfort or Savings (Eco):

In OPTI COMFORT mode, priority to comfort

In OPTI COMFORT mode, the thermostat's inbuilt algorithm optimises in order to guarantee maximum comfort during the COMFORT programme.

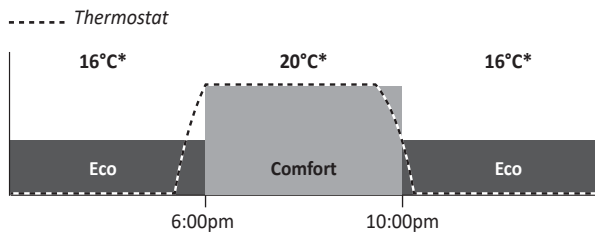

*Default temperature setting

The processor within the thermostat starts the boiler operation at the optimum time to achieve the setpoint temperature at the start of the occupancy period.

In this mode, the priority is given to anticipating and maintaining the comfort temperature during periods of occupancy.



PROGRAMMING

SET DATE AND CLOCK

1- Move the Programming slider to position **1**. The default year 2019 is flashing. Turn the dial clockwise to increment the year. Turn the dial counter-clockwise to decrement the year.



Press Enter to confirm and go to next setting.

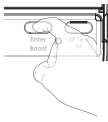

2- The default month 01 is flashing. Turn the dial clockwise to increment the month. Turn the dial counter-clockwise to decrement the month.

01 = January; 02 = February; 03 = March; 04 = April; 05 = May; 06 = June; 07 = July; 08 = August; 09 = September; 10 = October; 11 = November; 12 = December.

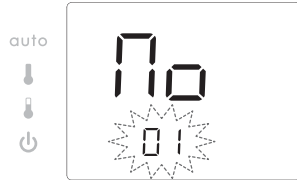

Press Enter to confirm and go to next setting.

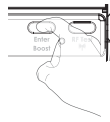

3- The default day 01 and the corresponding day underlining are flashing. Turn the dial clockwise to increment the day. Turn the dial counter-clockwise to decrement the day.

Mo = Monday ; Tu = Tuesday ; We = Wednesday ; Th = Thursday ; Fr = Friday ; Sa = Saturday ; Su = Sunday

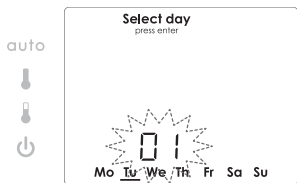

Press Enter to confirm and go to next setting.

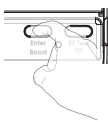

4- The default time 12.00 is flashing. To set the current time, turn the dial clockwise, to increment the time, turn the dial counter-clockwise, to decrement the time.



Press Enter or slide the programming slider to any other position to confirm/finish this setting.



Note regarding the clock: The summer/winter change will be performed automatically by the room thermostat. To disable this feature, refer to the installation instructions/ advanced installer settings.

SET THE PROGRAM DAY

1- Move the Programming slider to position **Prog**. The current day setting is flashing. The default day is Monday.



2- **Option 1:** Single day programming. Rotate dial to day required, eg Monday, press Enter. Underscore will become solid. Move the Program slider to any other position to confirm/finish this setting.



Option 2: Multiday programming.

Select first day by pressing enter then turn the dial to right, to add additional days to be programmed and press Enter to confirm each additional day.

Move the Program slider to any other position to confirm/finish this setting.



SET THE PROGRAM COMFORT PERIOD

1- To set the first Comfort start time, move the Programming slider to position **1**. The default time is 6:30am.



2- Turn the dial to set the time. Move the Program slider to the next position to confirm/finish this setting.



3- To set the first Comfort end time, move the Programming slider to position **1**. The default time is 8:30am.

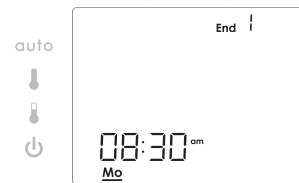

4- Turn the dial to set the time. Move the Program slider to the next position to confirm/finish this setting.



5- Repeat for the second comfort period **2**, and for the third comfort period **3**.

Comfort period	Default times	
Comfort period 2	Start at 12:00 pm	End at 02:00 pm
Comfort period 3	Start at 05:00 pm	End at 10:00 pm

Note: if you wish not to use a period then this can be done by Coinciding the End time with Start time.

Customizable default Comfort temperature

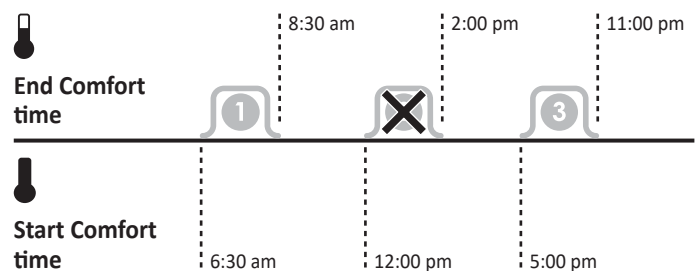

TEMPERATURES SETTING

Two temperatures can be set: Comfort temperature and Economy temperature.

- 1- To set the Comfort temperature, move the Programming slider to position 1. The default temperature is 20°C (68°F).

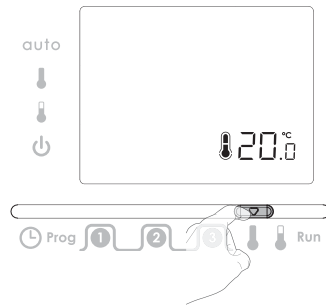

- 2- Turn the dial to set the temperature between 5°C and 30°C, in increments of 0.5°C. Move the Program slider to the next position to confirm/finish this setting.



- 3- To set the Economy temperature, move the Programming slider to position 3. The default temperature is 16°C (61°F).

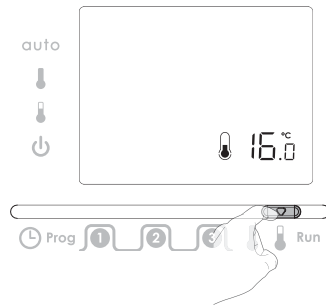

- 4- Turn the dial to set the temperature between 5°C and 30°C, in increments of 0.5°C. Move the Program slider to the next position to confirm/finish this setting.
NOTE: This is the temperature that the unit will work to outside of your comfort periods.

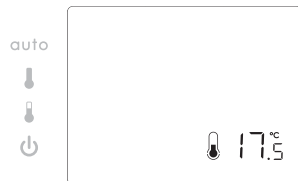

- 5- Move the program mode slider to the Run position to confirm and finish all previous settings.

OPERATING

MODE SELECTION AND DESCRIPTION

Mode sliders sequences:

Auto mode → Comfort mode → Economy mode → Standby.

AUTO: Automatic mode. The unit is controlling to the time and temperature program that have been selected (refer to "programming" section page 3).



COMFORT: Permanent comfort mode. The unit is controlling continuously to the comfort temperature setpoint. The default temperature setting is 20°C (68°F). Refer to section temperatures setting to change the value page 4.



ECO: Permanent eco mode. The unit is controlling continuously to the eco temperature setpoint. The default temperature setting is 16°C (61°F). Refer to section temperatures setting to change the value page 4.



STANDBY: Permanent standby mode with frost protection. The unit is controlling continuously at the frost protection temperature factory set. i.e 8°C.

Use it when you will be away from your home for a long time to protect your installation against frost.



MANUAL: A TEMPORARY CHANGE

MANUAL: Indicates when the temperature has been moved from setpoint. This temperature will operate until the next switching time. This is only active when the controller is in AUTO or COMFORT mode.



BOOST

BOOST: Boost mode is a temporary mode which allows you to operate at the comfort temperature for 1 hour. At the end of 1 hour the device will revert to its prior setting.

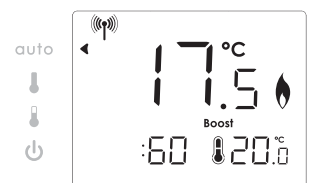

BOOST will work from any running mode. BOOST is entered by pressing Enter/Boost button.

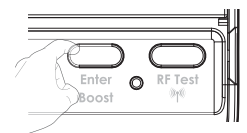

? TROUBLESHOOTING

BOOST is cancelled by any press of button, movement of dial or slider.
When BOOST is running the time and day disappear. The minute array will count down from 60 – 0 to indicate time left in BOOST mode.

Note: the Programming slider must be in the Run position.

OPERATING STATES OF THE SYSTEM

States of the indicator light	Operating states of the thermostat
Green	Receiver is connected to the thermostat
Orange	System is calling for heat
Red	RF Signal has been lost, no connection between thermostat and receiver. In order to re-bond the thermostat and receiver refer to the installation instructions

OVERRIDE

You can press the OVERRIDE button on the receiver to manually switch ON/OFF if you have a faulty room unit or transmission signal. This will operate until communication is restored.

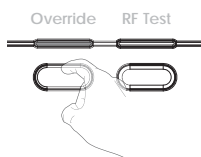

FACTORY SETTINGS

Settings	Factory settings	
Comfort temperature	20°C	
Eco temperature	16°C	
Comfort period 1	Start at 06:30 ^{am}	End at 08:30 ^{am}
Comfort period 2	Start at 12:00 ^{pm}	End at 02:00 ^{pm}
Comfort period 3	Start at 05:00 ^{pm}	End at 10:00 ^{pm}

Note: To restore factory settings, press and hold down this part for more than 3 seconds using the tip of a pen.

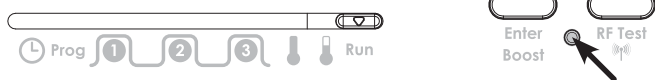

All LCD display will be turned ON for 2 seconds and the factory settings will be restored.

The boiler is not heating:

- Check that the Thermostat is calling for heat if yes then the thermostat would appear to be working check that the boiler has not switched itself off.
If no increase set temperature.
- Check the position of the batteries. Remove them for 30 seconds and reinsert them. If the problem persists, replace the 2 batteries.

Nothing in the display:

- Check the position of the batteries. Remove them for 30 seconds and reinsert them. If the problem persists, replace the 2 batteries.

The room temperature is not high enough, the boiler is not providing enough heat:

- Check the active operating mode (see page 4) - the room thermostat may be in an Eco, Standby or Auto Mode entailing a temperature drop.
- Check the active desired temperature and increase it if need be (see page 4).

The temperature in the room is lower than the setpoint temperature:

- Check the programming. The thermostat could be in a scheduled Eco period.
- Ensure that the time displayed is the same as the current time.

Frost protection in Standby mode:

- If the temperature around the Neomitis® thermostat falls below 8°C then the heating will be turned on automatically. This feature is included in order to protect your heating system from freezing, potentially causing damage and to priorities your comfort. This is indicated by the frost symbol appearing on your Neomitis® display screen.
- If the temperature around the Neomitis® receiver (normally located near to the boiler) falls below 5°C then the heating will be turned on automatically. This feature is included in order to protect your heating system from freezing and potentially causing damage. This is indicated by the frost symbol appearing on your Neomitis® display screen. (RF versions only).

You made a mistake while setting:

- You just need to restore factory settings, as explained in the “Factory settings” section (see page 5). This will reverse any changes you might have made.

The system is not heating but is on:

- If  and indicator light is on but the system remains cold, then you should contact your installer.

The thermostat is programmed and you observe a delay between the active mode Comfort or Eco and your requirement:

- The optimization function can generate slight offsets to guarantee the level of comfort at the right time or to save energy by slightly anticipating an Eco passage.

Heating comes on before programmed start time and comes off after programmed end time:

- Thermostat maybe set to OPTI Comfort mode. The thermostat will start the boiler at the optimum time to achieve the set point temperature at the start of the occupancy period. **(On cold days your heating may come on earlier than expected in order for the programmed occupied temperature to be achieved).**
- To change the optimization type, refer to the installation instructions.

Heating does not come on at programmed start time and comes off before programmed end time:

- Thermostat maybe set to OPTI ECO mode. The thermostat will stop the boiler at the optimum time to slightly reduce the set point temperature before the end of the occupancy period. **(This helps you to save money on your heating bills).**
- To change the optimization type, refer to the installation instructions.

If the problem persists, then contact your installer.



TECHNICAL SPECIFICATIONS

Please refer to the installation instructions for any informations about batteries life, standards and product environment.

i NOTE

In some instances the unit may have been set with the service interval function enabled. By Law in rented accommodation, your gas boiler should be inspected/serviced annually to ensure it is working correctly.

This option is designed to remind the end user to contact the relevant person to have the annual service carried out on the boiler.

This function will be enabled and programmed by your Installer, maintenance Engineer, or Landlord.

If it has been set to do so, the unit will display a message on the screen to remind you that a boiler service is due.

The Service Due Soon countdown will be indicated up to 50 days before the Service is due to allow time to arrange for an engineer to attend, normal functions will continue during this stage.

At the end of this service due soon period, the unit will go to Service Due OFF at which point only the 1hour boost will operate on TMR7 and PRG7, if the unit is a thermostat RT1/RT7PLUS, it will operate at 20°C during this hour.

If PRG7 RF, Thermostat has no function.

? WHAT IS A ROOM THERMOSTAT



... an explanation for householders

A room thermostat simply switches the heating system on and off as necessary. It works by sensing the air temperature, switching on the heating when the air temperature falls below the thermostat setting, and switching it off once this set temperature has been reached.

Turning a room thermostat to a higher setting will not make the room heat up any faster. How quickly the room heats up de-

pends on the design of the heating system, for example, the size of boiler and radiators. Neither does the setting affect how quickly the room cools down.

Turning a room thermostat to a lower setting will result in the room being controlled at a lower temperature, and saves energy.

The heating system will not work if a time switch or programmer has switched it off. The way to set and use your room thermostat is to find the lowest temperature setting that you are comfortable with, and then leave it alone to do its job. The best way to do this is to set the room thermostat to a low temperature – say 18°C – and then turn it up by one degree each day until you are comfortable with the temperature. You won't have to adjust the thermostat further. Any adjustment above this setting will waste energy and cost you more money.

If your heating system is a boiler with radiators, there will usually be only one room thermostat to control the whole house. But you can have different temperatures in individual rooms by installing thermostatic radiator valves (TRVs) on individual radiators. If you don't have TRVs, you should choose a temperature that is reasonable for the whole house. If you do have TRVs, you can choose a slightly higher setting to make sure that even the coldest room is comfortable, then prevent any overheating in other rooms by adjusting the TRVs.

Room thermostats need a free flow of air to sense the temperature, so they must not be covered by curtains or blocked by furniture. Nearby electric fires, televisions, wall or table lamps may prevent the thermostat from working properly.



www.neomitis.com



NEOMITIS[®]

Creating innovative solutions for ambient comfort

NEOMITIS[®] LIMITED - 4th Floor, Lincoln House, 300 High Holborn, London WC1V 7JH
Registered in England and Wales No: 9543404
Tel: +44 (0) 2071 250 236 - Fax: +44 (0) 2071 250 267 - E-mail: contactuk@neomitis.com